









ARCHITECTURAL

ESSENTIALS

# TABLE OF CONTENTS

Sconces	01
Ceiling & Pendants	63
Pathways	71

## LEGEND

 LED	LED Lighting		Rotatable Light
	ADA Compliant		Up/Down Lighting
	Wet Location		Adjustable
	Damp Location		CA Title 24
			Dimmable

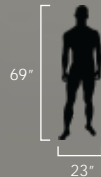

Model dimensions for  
**larger** fixture schematics

# ARCHITECTURAL

## ESSENTIALS



Our state of the art Fulcrum collection of LED luminaries is manufactured to the highest standards of technology available. Comprised of sleek, architectural designs and machined out of solid stock aluminum, these pieces have applications in both residential and commercial installation. Fulcrum is a full range of products that include interior and exterior sconces, pendant, ceiling mounts, bath vanities and step lights. The line is effortlessly married into contemporary and transitional settings since it is both abundant in selections and minimalist in their design.

# SCONCES

INTERIOR & EXTERIOR

Bring the outdoors inside with our line of high quality interior and exterior wall sconces. European in design and machined out of blocks of solid Aluminum, these sconces have both the look and quality expected for the discriminate buyer. High powered LEDs create dramatic light effects and most are approved for wet location applications.





- Machined Aluminum
- ADA Compliant
- ETL & cETL wet location listed, IP65 rated
- Available in 120V and 220V-277V
- Driver located within fixture
- 50,000 hours rated life
- 3000K Color Temperature
- 80+ CRI
- Indirect wall lighting creates light pattern effect



SM451386WT

\*220V & 277V available for special order

Model	SM451386
Dimensions	4.5"W x 4.5"H x 3"E, 2.25" HCO
Lamping	4W LED PCB (Integrated) LED lm: 360, Delivered lm: 75 CRI 80+, 3000K 120V
Size Options	4.5" 
Certifications	  
Available Finishes	 SA  WT

SA - Satin Aluminum, WT - White



- Machined Aluminum
- ADA Compliant
- Interior/Exterior
- ETL & cETL wet location listed, IP65 rated
- Available in 120V and 220V-277V
- Driver located within fixture
- Dimmable with Triac dimmer
- 50,000 hours rated life
- 3000K Color Temperature
- 90+ CRI
- Indirect backlight



SM451284WT

\*220V & 277V available for special order

Model	SM451284
Dimensions	8"W x 8"H x 1.5"E, 5.5" HCO
Lamping	10W LED (Integrated) Rated lm: 700, Delivered lm: 658 CRI 90+, 3000K 120V
Size Options	
Certifications	
Available Finishes	

SA - Satin Aluminum, WT - White





SM451280WT

\*220V & 277V available for special order

<b>Model</b>	SM451280
<b>Dimensions</b>	10"W x 10"H x 1.5"E, 5" HCO
<b>Lamping</b>	15W LED (Integrated) Rated lm: 1050, Delivered lm: 831 CRI 90+, 3000K 120V
<b>Size Options</b>	
<b>Certifications</b>	
<b>Available Finishes</b>	 SA      WT

SA - Satin Aluminum, WT - White



- Machined Aluminum
- ADA Compliant
- ETL & cETL wet location listed, IP65 rated
- Available in 120V and 220V-277V
- Driver located within fixture
- Dimmable with Triac dimmer
- 50,000 hours rated life
- 3000K Color Temperature
- 90+ CRI
- Can be mounted horizontally/vertically



\*220V & 277V available for special order

Model	SM451290
Dimensions	5.25"W x 18"H x 2.75"E, 9" HCO
Lamping	7W LED (Integrated) Rated lm: 490, Delivered lm: 35 CRI 90+, 3000K 120V
Size Options	
Certifications	
Available Finishes	 BKSA      BZ



SM451290BZ

BKSA - Black/Satin Aluminum, BZ - Bronze



SM451292BKSA

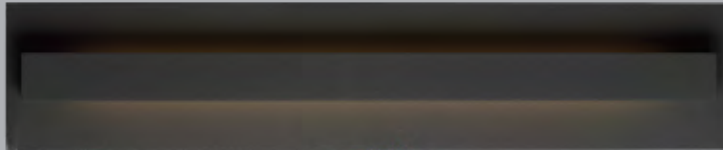

SM451294BZ

\*220V & 277V available for special order

Model	SM451292	SM451294
Dimensions	5.25"W x 24"H x 2.75"E, 12" HCO	6"W x 30"H x 2.75"E, 15" HCO
Lamping	11W LED (integrated) Rated lm: 770, Delivered lm: 58 CRI 90+, 3000K 120V	15W LED (integrated) Rated lm: 1050, Delivered lm: 75 CRI 90+, 3000K 120V
Size Options		
Certifications		
Available Finishes		

BKSA - Black/Satin Aluminum, BZ - Bronze

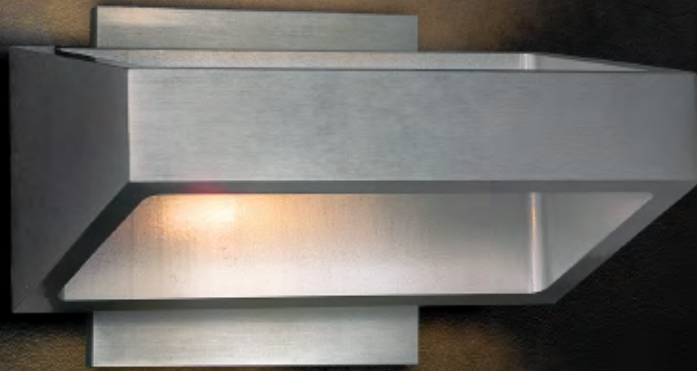

\*220V & 277V available for special order

Model	SM451302
Dimensions	7.25"W x 4.5"H x 5.25"E, 2.25" HCO
Lamping	5.4W LED PCB (Integrated) Rated lm: 540, Delivered lm: 445 CRI 80+, 3000K 120V
Size Options	
Certifications	
Available Finishes	



SM451302WT

SA - Satin Aluminum, WT - White

- Machined Aluminum
- ETL & cETL wet location listed, IP65 rated
- Available in 120V and 220V-277V
- Driver located within fixture
- 5,000 hours rated life
- 3000K Color Temperature
- 80+ CRI

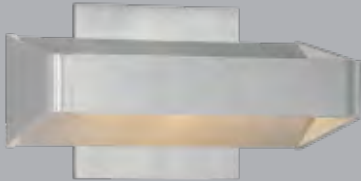

SM451304SA



SM451305SA

\*220V & 277V available for special order

Model	SM451304	SM451305
Dimensions	8"W x 4.5"H x 4.25"E, 2.25"HCO	15.75"W x 4.5"H x 4.25"E, 2.25" HCO
Lamping	6W LED PCB (integrated) LED lm: 320, Delivered lm: 140 CRI 80+, 3000K 120V	8.1W LED PCB (integrated) Rated lm: 310, Delivered lm: 310 CRI 80+, 3000K 120V
Size Options		
Certifications		
Available Finishes	 SA	

SA - Satin Aluminum



- Machined Aluminum
- ADA Compliant
- ETL & cETL wet location listed, IP65 rated
- Available in 120V and 220V-277V
- Driver located within fixture
- Dimmable with Triac dimmer
- 50,000 hours rated life
- 3000K Color Temperature
- 90+ CRI
- Can be mounted horizontally/vertically
- Indirect backlight



SM451335WT

\*220V & 277V available for special order

Model	SM451335
Dimensions	9.75"W x 14"H x 2.75"E, 7" HCO
Lamping	15W LED (integrated) Rated lm: 1050, Delivered lm: 51 CRI 90+, 3000K 120V
Size Options	
Certifications	
Available Finishes	

BKSA - Black/Satin Aluminum, WT - White

- Machined Aluminum
- ADA Compliant
- Title 24 listed
- ETL & cETL wet location listed, IP65 rated
- Available in 120V and 220V-277V
- Driver located within fixture
- 50,000 hours rated life
- 3000K Color Temperature
- 90+ CRI
- Indirect backlight



SM451307WT

\*220V & 277V available for special order

Model	SM451307
Dimensions	4.25"W x 16"H x 3.5"E, 12.5"HCO
Lamping	5 x 1W LED PCB (integrated) LED lm: 432, Delivered lm: 259 CRI 90+, 3000K 120V
Size Options	
Certifications	
Available Finishes	

SA - Satin Aluminum, WT - White



- Machined Aluminum
- ETL & cETL wet location listed, IP65 rated
- Available in 120V and 220V-277V
- Driver located within fixture
- 35,000 hours rated life
- 3000K Color Temperature
- 90+ CRI
- Adjustable wall-lighting effect for up/down or both





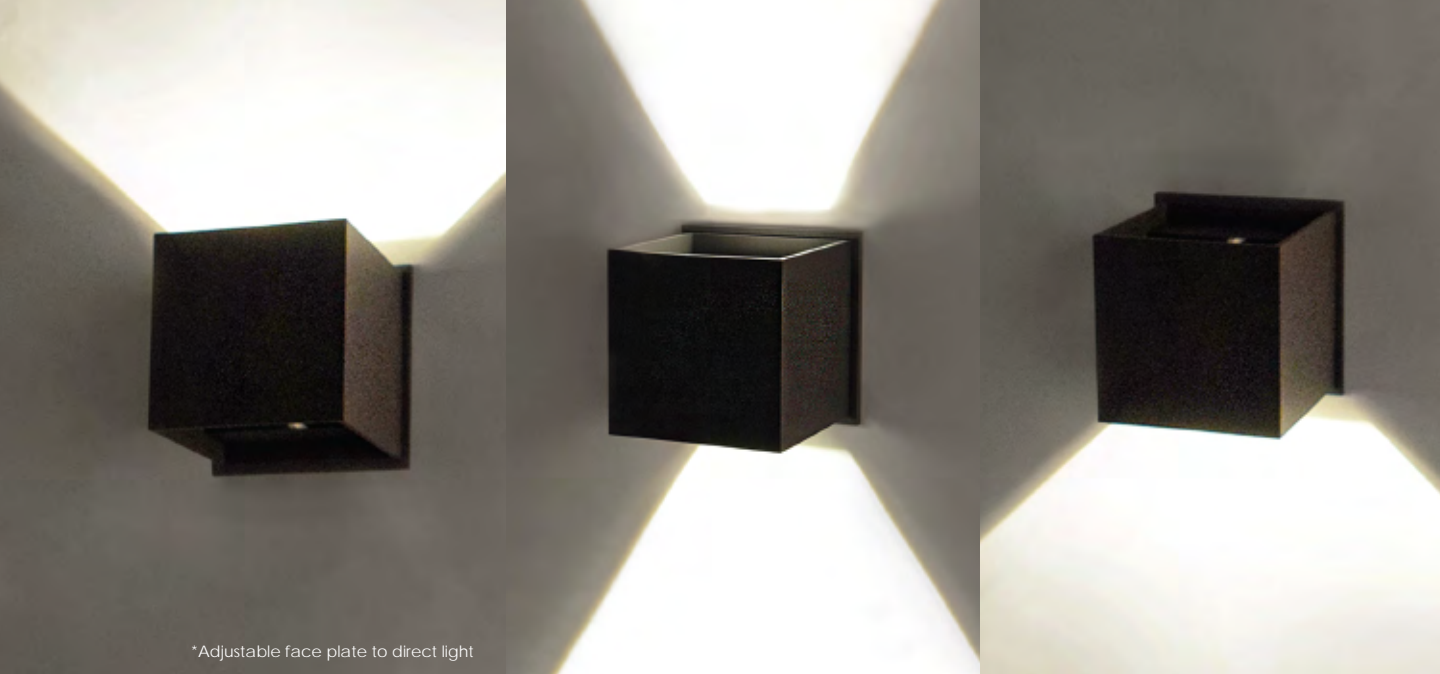

\*Adjustable face plate to direct light

\*220V & 277V available for special order

Model	SM451308
Dimensions	4.5"W x 4.5"H x 4.25"E, 2.25" HCO
Lamping	6W LED PCB (Integrated) Rated lm: 420, Delivered lm: 316 CRI 90+, 3000K 120V
Size Options	
Certifications	
Available Finishes	

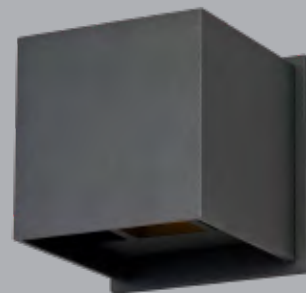



SM451308BZ

BZ - Bronze, SA - Satin Aluminum

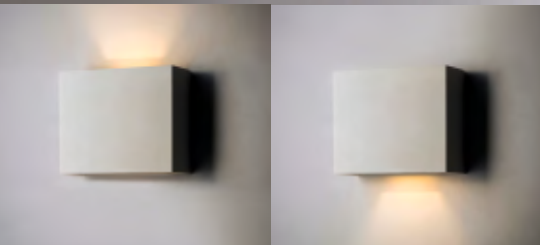
- Machined Aluminum
- ADA Compliant
- ETL & cETL wet location listed, IP65 rated
- Available in 120V and 220V-277V
- Driver located within fixture
- Dimmable with Triac dimmer
- 50,000 hours rated life
- 3000K Color Temperature
- 90+ CRI
- Adjustable wall-lighting effect for up/down or both

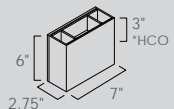

\*220V & 277V available for special order

Model	SM451328
Dimensions	7"W x 6"H x 2.75"E, 3" HCO
Lamping	6W COB LED (integrated) LED lm: 420, Delivered lm: 344 CRI 90+, 3000K 120V
Size Options	
Certifications	
Available Finishes	 SA WT



SM451328WT

SA - Satin Aluminum, WT - White

- Machined Aluminum
- ADA Compliant
- Title 24 listed
- ETL & cETL wet location listed, IP65 rated
- Available in 120V and 220V-277V
- Driver located within fixture
- Dimmable with Triac dimmer
- 35,000 hours rated life
- 3000K Color Temperature
- 90+ CRI
- Up/Down light



\*220V & 277V available for special order

Model	SM451310
Dimensions	6.75"W x 4.25"H x 1.75"E, 2.25" HCO
Lamping	10.8W LED PCB (integrated) Rated lm: 756, Delivered lm: 504 CRI 90+, 3000K 120V
Size Options	
Certifications	
Available Finishes	 BZ      SA

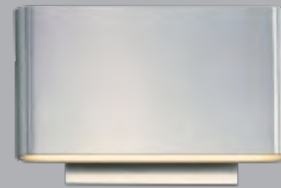

SM451310SA

BZ - Bronze, SA - Satin Aluminum



- Machined Aluminum
- ADA Compliant
- ETL & cETL wet location listed, IP65 rated
- Available in 120V and 220V-277V
- Driver located within fixture
- 35,000 hours rated life
- 3000K Color Temperature
- 90+ CRI



SM451524WT



SM451526BZ

\*220V & 277V available for special order

Model	SM451524	SM451526
Dimensions	4.25"W x 13.75"H x 3.5"E, 11.75" HCO	4.25"W x 23.5"H x 3.5"E, 11.75" HCO
Lamping	4W LED PCB (integrated) Rated lm: 560, Delivered lm: 503 CRI 90+, 3000K 120V	2 x 4W LED PCB (integrated) Rated lm: 560, Delivered lm: 480 CRI 90+, 3000K 120V
Size Options		
Certifications		
Available Finishes		

BZ - Bronze, WT - White

- Machined Aluminum
- ADA Compliant
- ETL & cETL wet location listed, IP65 rated
- Available in 120V and 220V-277V
- Driver located within fixture
- 50,000 hours rated life
- 3000K Color Temperature
- 80+ CRI

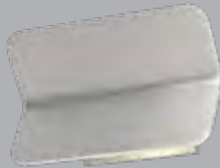

SM451309SA

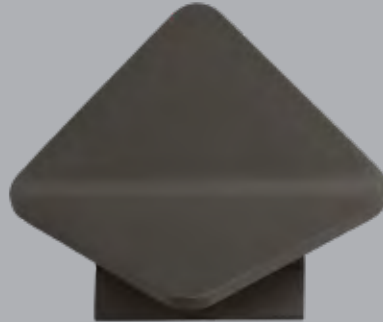

SM451318BZ

\*220V & 277V available for special order

Model	SM451309	SM451318
Dimensions	8"W x 4.75"H x 2.75"E, 2.5" HCO	14"W x 6.75"H x 3.5"E, 3.44" HCO
Lamping	6W LED PCB (Integrated) Rated lm: 420, Delivered lm: 362 CRI 80+, 3000K 120V	6W LED PCB (Integrated) Rated lm: 420, Delivered lm: 428 CRI 80+, 3000K 120V
Size Options		
Certifications		
Available Finishes	<p>SA</p>	<p>BZ SA</p>

BZ - Bronze, SA - Satin Aluminum

- Machined Aluminum
- ADA Compliant
- ETL & cETL wet location listed, IP65 rated
- Available in 120V and 220V-277V
- Driver located within fixture
- Dimmable with Electronic Low Voltage dimmer
- 3000K Color Temperature
- 90+ CRI
- Can be mounted horizontally/vertically



SM451486SA

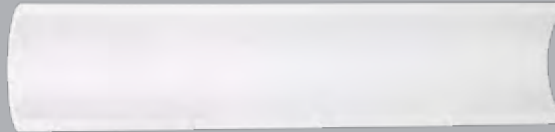

SM451488WT

\*220V & 277V available for special order

Model	SM451486	SM451488
<b>Dimensions</b>	7.88"W x 5.1"H x 2.4"E, 4.7" HCO	23.64"W x 5.1"H x 2.4"E, 12" HCO
<b>Lamping</b>	16W LED PCB (integrated) Rated lm: 1120, Delivered lm: 380 CRI 90+, 3000K	30W LED PCB (integrated) Rated lm: 2100, Delivered lm: 1390 CRI 90+, 3000K
<b>Size Options</b>		
<b>Certifications</b>		
<b>Available Finishes</b>		

BZ - Bronze, SA - Satin Aluminum, WT - White

- Machined Aluminum
- ETL & cETL wet location listed, IP65 rated
- Available in 120V and 220V-277V
- Driver located within fixture
- Dimmable with Electronic Low Voltage dimmer
- 3000K Color Temperature
- 90+ CRI
- Indirect backlight and downlight



SM451497BZ



SM451499WT

\*220V & 277V available for special order

Model	SM451497	SM451499
Dimensions	8"W x 20"H x 4"E, 16" HCO	10"W x 28"H x 4.25"E, 24" HCO
Lamping	24W LED PCB (integrated) Rated lm: 1680 CRI 90+, 3000K 120V	28W LED PCB (integrated) Rated lm: 1960 CRI 90+, 3000K 120V
Size Options		
Certifications		
Available Finishes		

BZ - Bronze, SA - Satin Aluminum, WT - White





- Machined Aluminum
- ADA Compliant
- ETL & cETL wet location listed, IP65 rated
- Available in 120V and 220V-277V
- Driver located within fixture
- Dimmable with Electronic Low Voltage dimmer
- 3000K Color Temperature
- 90+ CRI
- Indirect backlight



\*220V & 277V available for special order

<b>Model</b>	SM451500
<b>Dimensions</b>	6"W x 6"H x 1.5"E, 3" HCO
<b>Lamping</b>	5W LED PCB (integrated) Rated lm: 350 CRI 90+, 3000K 120V
<b>Size Options</b>	
<b>Certifications</b>	
<b>Available Finishes</b>	



SM451500BZ

BZ - Bronze, SA- Satin Aluminum, WT - White

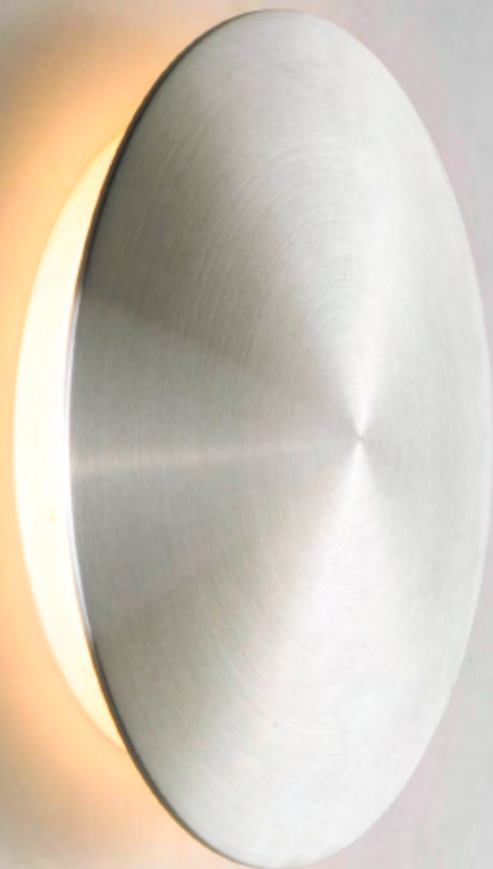

- Machined Aluminum
- ADA Compliant
- ETL & cETL wet location listed, IP65 rated
- Available in 120V and 220V-277V
- Driver located within fixture
- Dimmable with Triac dimmer
- 50,000 hours rated life
- 3000K Color Temperature
- 90+ CRI
- Can be mounted horizontally/vertically



\*220V & 277V available for special order

Model	SM451334
Dimensions	15.75"W x 9.25"H x 1.75"E, 6.75" HCO
Lamping	21W LED (integrated) LED lm: 1470, Delivered lm: 1432 CRI 90+, 3000K 120V
Size Options	
Certifications	
Available Finishes	

BZ - Bronze, SA - Satin Aluminum, WT - White



- Machined Aluminum
- ADA Compliant
- ETL & cETL wet location listed, IP65 rated
- Available in 120V and 220V-277V
- Driver located within fixture
- Dimmable with Electronic Low Voltage dimmer
- 3000K Color Temperature
- 90+ CRI



\*220V & 277V available for special order

<b>Model</b>	SM451329
<b>Dimensions</b>	4.5"W x 4.5"H x 0.75"E, 3.25" HCO
<b>Lamping</b>	8W LED PCB (Integrated) Rated lm: 560, Delivered lm: 70 CRI 90+, 3000K 120V
<b>Size Options</b>	
<b>Certifications</b>	
<b>Available Finishes</b>	

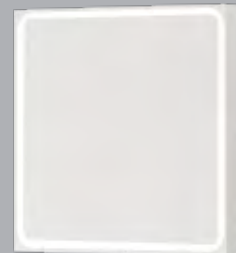

SM451329WT

SA - Satin Aluminum, WT - White



- Machined Aluminum
- ADA Compliant
- Interior/Exterior
- ETL & cETL wet location listed, IP65 rated
- Available in 120V and 220V-277V
- Driver located within fixture
- Dimmable with Electronic Low Voltage dimmer
- 3000K Color Temperature
- 90+ CRI
- Indirect backlight



SM451493SA



SM451495WT

\*220V & 277V available for special order

Model	SM451493	SM451495
Dimensions	10"W x 14.25"H x 3.25"E, 9.5" HCO	13.5"W x 19.25"H x 3.25"E, 14" HCO
Lamping	21W LED PCB (integrated) Rated lm: 1470, Delivered lm: 945 CRI 90+, 3000K 120V	25W LED PCB (integrated) Rated lm: 1750, Delivered lm: 1370 CRI 90+, 3000K 120V
Size Options		
Certificates		
Available Finishes		

BZ - Bronze, SA - Satin Aluminum, WT - White

- Machined Aluminum
- ADA Compliant
- ETL & cETL wet location listed, IP65 rated
- Available in 120V and 220V-277V
- Driver located within fixture
- Dimmable with Electronic Low Voltage dimmer
- 3000K Color Temperature
- 90+ CRI
- Up/Down light

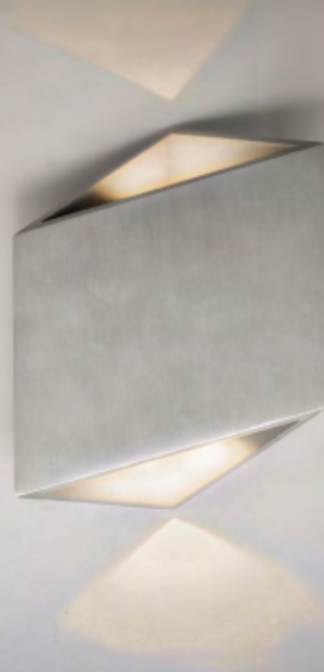

\*220V & 277V available for special order

Model	SM451373
Dimensions	7"W x 8.5"H x 2.5"E, 4.25"HCO
Lamping	7W LED PCB (integrated) LED lm: 490, Delivered lm: 460 CRI 90+, 3000K 120V
Size Options	
Certifications	
Available Finishes	 SA      WT



SM451373WT

SA - Satin Aluminum, WT - White



- Machined Aluminum
- Interior/Exterior
- ETL & cETL wet location listed, IP65 rated
- Available in 120V and 220V-277V
- Driver located within fixture
- 35,000 hours rated life
- 3000K Color Temperature
- 80+ CRI

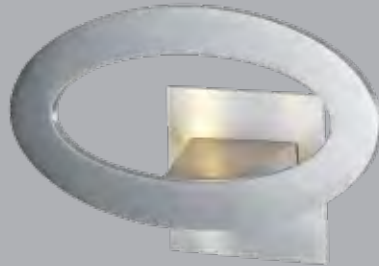

SM451300SA



SM451321BZ

\*220V & 277V available for special order

Model	SM451300	SM451321
Dimensions	10"W x 8"H X 3.5"E, 5" HCO	7.75"W x 7.75"H x 4.5"E, 3.72" HCO
Lamping	7W LED PCB (integrated) Rated lm: 700, Delivered lm: 367 CRI 80+, 3000K 120V	28 x 8.4W LED PCB (integrated) Rated lm: 560, Delivered lm: 440 CRI 80+, 3000K 120V
Size Options		
Certifications		
Available Finishes		

BZ - Bronze, SA - Satin Aluminum

- Machined Aluminum
- ADA Compliant
- ETL & cETL wet location listed, IP65 rated
- Available in 120V and 220V-277V
- Driver located within fixture
- Dimmable with Electronic Low Voltage dimmer
- 3000K Color Temperature
- 90+ CRI
- Up/Down light
- Combine pieces to create wall light pattern
- Directionally adjustable in field



SM451534BZ  
4-Light

\*220V & 277V available for special order

Model	SM451534
Dimensions	4.75"W x 4.75"H x 3.5"E, 2.5" HCO
Lamping	4 x 3W LED PCB (integrated) Rated lm: 840, Delivered lm: 450 CRI 90+, 3000K 120V
Size Options	
Certifications	
Available Finishes	 BZ



SM451534BZ

BZ - Bronze

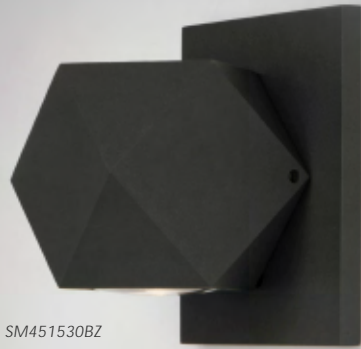

SM451530BZ  
1-Light

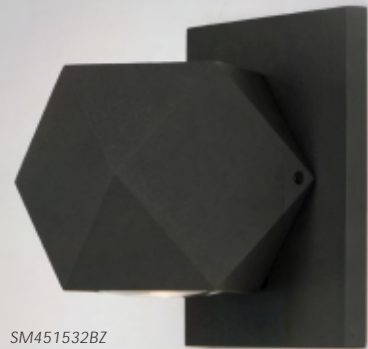

SM451532BZ  
2-Light

\*220V & 277V available for special order

Model	SM451530	SM451532
Dimensions	4.75"W x 4.75"H x 3.5"E, 2.5" HCO	4.75"W x 4.75"H x 3.5"E, 2.5" HCO
Lamping	1 x 3W LED PCB (integrated) Rated lm: 210, Delivered lm: 135 CRI 80+, 3000K 120V	2 x 3W LED PCB (integrated) Rated lm: 420, Delivered lm: 270 CRI 90+, 3000K 120V
Size Options		
Certifications		
Available Finishes	 BZ	

BZ - Bronze





- Machined Aluminum
- ADA Compliant
- ETL & cETL wet location listed, IP65 rated
- Available in 120V and 220V-277V
- Driver located within fixture
- Dimmable with Electronic Low Voltage dimmer
- 50,000 hours rated life
- 3000K Color Temperature
- 90+ CRI
- Indirect backlight

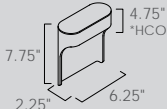

SM451330BZ

\*220V & 277V available for special order

Model	SM451330
Dimensions	6.25"W x 7.75"H x 2.25"E, 4.75" HCO
Lamping	8W COB LED (integrated) LED lm: 560, Delivered lm: 337 CRI 90+, 3000K 120V
Size Options	
Certifications	
Available Finishes	 BZ      SA

BZ - Bronze, SA - Satin Aluminum

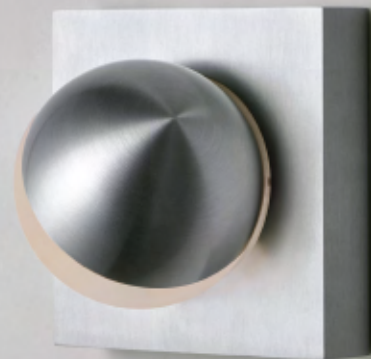
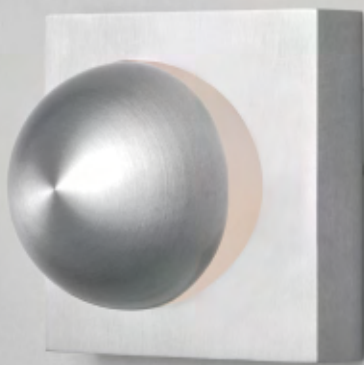

\*Adjustable sphere for light direction

\*220V & 277V available for special order

<b>Model</b>	<b>SM451326</b>
<b>Dimensions</b>	4.25"W x 4.25"H x 3.5"E, 3.5" HCO
<b>Lamping</b>	4W LED PCB (integrated) Rated lm: 280, Delivered lm: 140 CRI 90+, 3000K 120V
<b>Size Options</b>	
<b>Certifications</b>	
<b>Available Finishes</b>	

- Machined Aluminum
- ADA Compliant
- ETL & cETL wet location listed, IP65 rated
- Available in 120V and 220V-277V
- Driver located within fixture
- Dimmable with Electronic Low Voltage dimmer
- 3000K Color Temperature
- 90+ CRI
- Up/Down light
- Adjustable wall-lighting effect for directional lighting



SM451326WT

SA - Satin Aluminum, WT - White



- Machined Aluminum
- ADA Compliant
- ETL & cETL wet location listed, IP65 rated
- Available in 120V and 220V-277V
- Driver located within fixture
- Dimmable with Triac dimmer
- 3000K Color Temperature
- 90+ CRI
- Up/Down light
- Adjustable wall-lighting effect for up/down or both



SM451333WT



\*220V & 277V available for special order

Model	SM451333
Dimensions	5"W x 7"H x 2.27"E, 3.5"HCO
Lamping	8W LED PCB (integrated) LED lm: 560, Delivered lm: 170 CRI 90+, 3000K 120V
Size Options	
Certifications	
Available Finishes	

SA - Satin Aluminum, WT - White



- Machined Aluminum
- ADA Compliant
- ETL & cETL wet location listed, IP65 rated
- Available in 120V and 220V-277V
- Driver located within fixture
- Dimmable with Electronic Low Voltage dimmer
- 3000K Color Temperature
- 80+ CRI
- Up/Down light
- Combine pieces to create wall light pattern
- Directionally adjustable in field

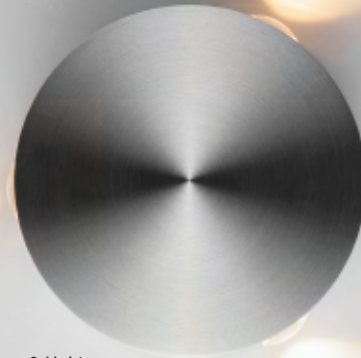

**3-Light**  
SM451544SA

\*220V & 277V available for special order

<b>Model</b>	SM451544
<b>Dimensions</b>	4.75"W x 5"H x 1.5"E, 2.5" HCO
<b>Lamping</b>	3 x 4W LED PCB (integrated) Rated lm: 840, Delivered lm: 1150 CRI 90+, 3000K 120V
<b>Size Options</b>	
<b>Certifications</b>	
<b>Available Finishes</b>	 SA      WT



SM451544SA

SA - Satin Aluminum, WT - White





\*220V & 277V available for special order

Model	SM451540	SM451542
Dimensions	4.75"W x 5"H x 1.5"E, 2.5" HCO	4.75"W x 5"H x 1.5"E, 2.5" HCO
Lamping	1 x 4W LED PCB (integrated) Rated lm: 280, Delivered lm: 320 CRI 90+, 3000K 120V	2 x 4W LED PCB (integrated) Rated lm: 560, Delivered lm: 683 CRI 90+, 3000K 120V
Size Options		
Certifications		
Available Finishes		

SA - Satin Aluminum, WT - White

- Machined Aluminum
- ADA Compliant
- ETL & cETL wet location listed, IP65 rated
- Available in 120V and 220V-277V
- Driver located within fixture
- Dimmable with Electronic Low Voltage dimmer
- 3000K Color Temperature
- 80+ CRI
- Directionally adjustable



SM451374BZ

\*220V & 277V available for special order

Model	SM451374
Dimensions	4.75"W x 4.75"H x 2.5"E, 2.25" HCO
Lamping	4W LED PCB (integrated) LED lm: 360, Delivered lm: 280 CRI 80+, 3000K 120V
Size Options	
Certifications	
Available Finishes	 BZ SA

BZ - Bronze, SA - Satin Aluminum

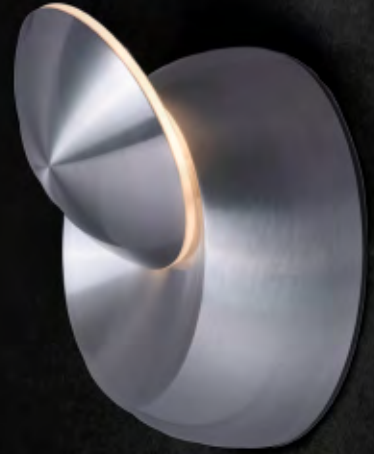
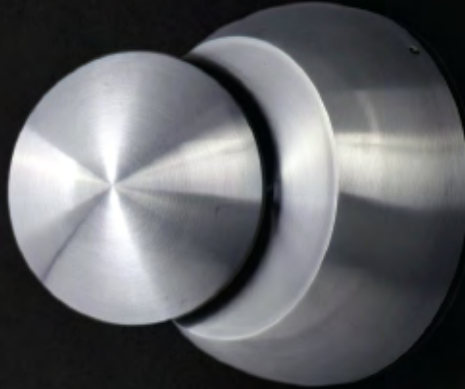
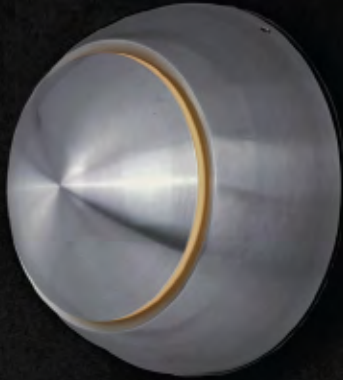

\*Adjustable face plate to direct light

\*220V & 277V available for special order

Model	SM451375
Dimensions	6.25"W x 6.25"H x 3.25"E, 3.25" HCO
Lamping	4W LED PCB (Integrated) Rated lm: 360, Delivered lm: 280 CRI 90+, 3000K 120V
Size Options	
Certifications	
Available Finishes	

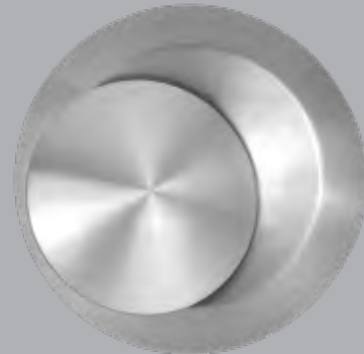

SM451375SA

BZ - Bronze, SA - Satin Aluminum

- Machined Aluminum
- ADA Compliant
- ETL & cETL wet location listed, IP65 rated
- Available in 120V and 220V-277V
- Driver located within fixture
- Dimmable with Electronic Low Voltage dimmer
- 3000K Color Temperature
- 90+ CRI





SM451502WT



SM451504SA

\*220V & 277V available for special order

Model	SM451502	SM451504
Dimensions	6.25"W x 6.25"H x 2.75"E, 3.25" HCO	7.75"W x 7.75"H x 2.25"E, 4" HCO
Lamping	8W LED PCB (integrated) Rated lm: 560, Delivered lm: 500 CRI 90+, 3000K 120V	12W LED PCB (integrated) Rated lm: 840, Delivered lm: 800 CRI 90+, 3000K 120V
Size Options		
Certificates		
Available Finishes		

BZ - Bronze, SA- Satin Aluminum, WT - White

- Machined Aluminum
- ADA Compliant
- ETL & cETL wet location listed, IP65 rated
- Available in 120V and 220V-277V
- Driver located within fixture
- 3000K Color Temperature
- 80+ CRI
- Indirect backlight





SM451376WT



SM451378WT

\*220V & 277V available for special order

Model	SM451376	SM451378
Dimensions	6"W x 6"H x 2"E, 3"HCO	9"W x 9"H x 2.25"E
Lamping	4W LED PCB (integrated) LED lm: 360, Delivered lm: 110 CRI 80+, 3000K 120V	5W LED PCB (integrated) LED lm: 500, Delivered lm: 295 CRI 80+, 3000K 120V
Size Options		
Certificates		
Available Finishes	 WT	

WT - White

- Machined Aluminum
- ADA Compliant
- ETL & cETL wet location listed, IP65 rated
- Available in 120V and 220V-277V
- Driver located within fixture
- 35,000 hours rated life
- 3000K Color Temperature
- 80+ CRI
- Indirect backlight and additional direct light



SM451381WT

\*220V & 277V available for special order

<b>Model</b>	SM451380
<b>Dimensions</b>	5.25"W x 5.25"H x 1.75"E, 2.75" HCO
<b>Lamping</b>	6W LED PCB (integrated) Rated lm: 600, Delivered lm: 295 CRI 80+, 3000K 120V
<b>Size Options</b>	
<b>Certifications</b>	
<b>Available Finishes</b>	



SM451380BZ

BZ - Bronze, WT - White





SM451381BZ



SM451382WT

\*220V & 277V available for special order







Model	SM451381	SM451382
Dimensions	7"W x 7"H x 1.75"E, 3.5" HCO	11.75"W x 11.75"H x 2.75"E, 6" HCO
Lamping	8W LED PCB (integrated) Rated lm: 800, Delivered lm: 505 CRI 80+, 3000K 120V	15W LED PCB (integrated) Rated lm: 1500, Delivered lm: 1250 CRI 80+, 3000K 120V
Size Options		
Certifications		
Available Finishes		

BZ - Bronze, WT - White

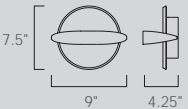
- Machined Aluminum
- Title 24 listed
- ETL & cETL wet location listed, IP65 rated
- Available in 120V and 220V-277V
- Driver located within fixture
- 35,000 hours rated life
- 3000K Color Temperature
- 80+ CRI
- Can be mounted horizontally/vertically
- Indirect wall lighting creates light pattern effect



\*220V & 277V available for special order

Model	SM451385
Dimensions	9"W x 7.5"H x 4.25"E, 4.25"HCO
Lamping	5W LED PCB (integrated) LED lm: 500, Delivered lm: 290 CRI 80+, 3000K 120V
Size Options	7.5" 
Certifications	   
Available Finishes	 WT



SM451385WT

WT - White

- Machined Aluminum
- ADA Compliant
- ETL & cETL wet location listed, IP65 rated
- Available in 120V and 220V-277V
- Driver located within fixture
- 3000K Color Temperature
- 90+ CRI
- Additional downlight
- Coordinating landscape lighting available (page 85)









SM451047WT

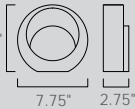
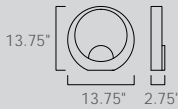

SM451048BZ

\*220V & 277V available for special order

Model	SM451047	SM451048
Dimensions	7.75"W x 7.5"H x 2.75"E, 5"HCO	13.75"W x 13.75"H x 2.75"E, 11"HCO
Lamping	9W LED PCB (integrated) LED lm: 630, Delivered lm: 550 CRI 90+, 3000K 120V	19W LED PCB (integrated) LED lm: 1330, Delivered lm: 680 CRI 90+, 3000K 120V
Size Options	7.5"  7.75" 2.75"	13.75"  13.75" 2.75"
Certifications	  	
Available Finishes	  BZ WT	

BZ - Bronze, WT - White

- Machined Aluminum
- ETL & cETL wet location listed, IP65 rated
- Available in 120V and 220V-277V
- Driver located within fixture
- 3000K Color Temperature
- 80+ CRI
- Can be mounted horizontally/vertically



SM451323BZ



SM451324SA

\*220V & 277V available for special order

Model	SM451323	SM451324
Dimensions	6"W x 4.25"H x 7.25"E, 2.16"HCO	17.75"W x 4.25"H x 7.25"E, 2.16"HCO
Lamping	2.7W LED PCB (Integrated) LED lm: 190, Delivered lm: 154 CRI 80+, 3000K 120V	8.1W LED PCB (Integrated) LED lm: 560, Delivered lm: 547 CRI 80+, 3000K 120V
Size Options		
Certificates		
Available Finishes		

BZ - Bronze, SA - Satin Aluminum



- Machined Aluminum
- ADA Compliant
- Title 24 listed
- ETL & cETL wet location listed, IP65 rated
- Available in 120V and 220V-277V
- Driver located within fixture
- Dimmable with Electronic Low Voltage dimmer
- 3000K Color Temperature
- 90+ CRI
- Additional downlight
- Coordinating landscape lighting (page 81)

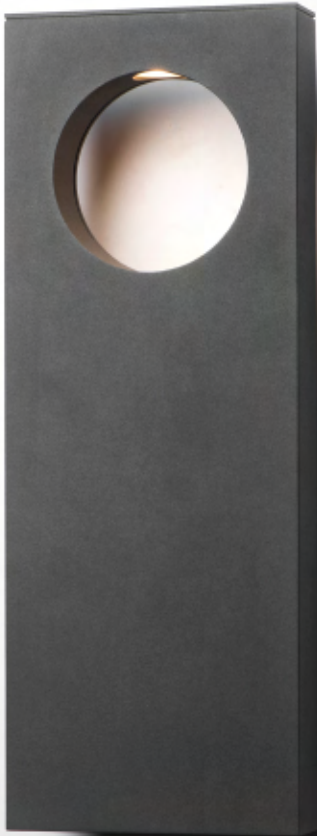

SM451368WT



\*220V & 277V available for special order

Model	SM451368
Dimensions	5.75"W x 16"H x 3.25"E, 8" HCO
Lamping	18W LED PCB (integrated) Rated lm: 1260, Delivered lm: 820 CRI 90+, 3000K 120V
Size Options	
Certifications	
Available Finishes	

BZ - Bronze, SA - Satin Aluminum, WT - White

- Machined Aluminum
- ETL & cETL wet location listed, IP65 rated
- Available in 120V and 220V-277V
- Driver located within fixture
- 3000K Color Temperature
- 80+ CRI



\*220V & 277V available for special order

<b>Model</b>	SM451319
<b>Dimensions</b>	5.25"W x 4.25"H x 6"E, 2.16" HCO
<b>Lamping</b>	3W LED PCB (Integrated) Rated lm: 210, Delivered lm: 91 CRI 80+, 3000K 120V
<b>Size Options</b>	
<b>Certifications</b>	
<b>Available Finishes</b>	 BZ      SA

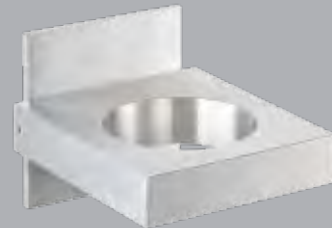

SM451319BZ

BZ - Bronze, SA - Satin Aluminum

- Machined Aluminum
- ETL & cETL wet location listed, IP65 rated
- Driver located within fixture
- 3000K Color Temperature
- 90+ CRI



Model	SM451490
Dimensions	9"W x 9"H x 4.25"E, 5.5" HCO
Lamping	9W LED PCB (Integrated) Rated lm: 1260 CRI 90+, 3000K 120V
Size Options	
Certifications	
Available Finishes	



SM451490WT

BZ - Bronze, WT - White



- Machined Aluminum
- Title 24 listed
- Available in 120V and 220V-277V
- Driver located within fixture
- 5,000 hours rated life
- 3000K Color Temperature
- 80+ CRI

- Machined Aluminum
- ADA Compliant
- ETL & cETL wet location listed, IP65 rated
- Available in 120V and 220V-277V
- Driver located within fixture
- Dimmable with Electronic Low Voltage dimmer
- 3000K Color Temperature
- 90+ CRI



SM451312WT



SM451485BZ

Model	SM451312	SM451485
Dimensions	7"W x 8"H x 5.75"E, 3.75" HCO	7.88"W x 5.7"H x 3.9"E, 5" HCO
Lamping	6W LED PCB (integrated) Rated lm: 141, Delivered lm: 39 CRI 80+, 3000K 120V	18W LED PCB (integrated) Rated lm: 560, Delivered lm: 378 CRI 90+, 3000K 120V
Size Options		
Certifications		
Available Finishes		

BZ - Bronze, SA - Satin Aluminum, WT - White



- Machined Aluminum
- ADA Compliant
- ETL & cETL wet location listed, IP65 rated
- Available in 120V and 220V-277V
- Driver located within fixture
- 50,000 hours rated life
- 3000K Color Temperature
- 80+ CRI
- Indirect backlight



SM451388SA

\*220V & 277V available for special order

Model	SM451388
Dimensions	6"W x 6"H x 2"E, 3"HCO
Lamping	8.4W LED (integrated) LED lm: 720, Delivered lm: 490 CRI 80+, 3000K 120V
Size Options	
Certifications	
Available Finishes	 SA WT

SA - Satin Aluminum, WT - White

- Machined Aluminum
- Driver located within fixture
- Dimmable with Electronic Low Voltage dimmer
- 3000K Color Temperature
- 90+ CRI
- Can be installed as either flush mount or wall sconce
- Adjustable dish to direct light



\*Adjustable dish to direct light

<b>Model</b>	SM451470
<b>Dimensions</b>	7.75"W x 4.25"H x 7.75"L
<b>Lamping</b>	15W LED (integrated) LED lm: 1350, Delivered lm: 1150 CRI 90+, 3000K 120V
<b>Size Options</b>	4.25"  7.75"
<b>Certifications</b>	
<b>Available Finishes</b>	 WT



WT - White



- Machined Aluminum
- ETL & cETL wet location listed, IP65 rated
- Available in 120V and 220V-277V
- Driver located within fixture
- Dimmable with Electronic Low Voltage dimmer
- 3000K Color Temperature
- 90+ CRI
- Fixture pivots 180° to direct light
- Coordinating pendants available (pg. 67)



SM451460WT



\*220V & 277V available for special order

<b>Model</b>	SM451460
<b>Dimensions</b>	4.25" W x 15.25" H x 4.25" E, 13" HCO
<b>Lamping</b>	8W LED PCB (integrated) LED lm: 560, Delivered lm: 430 CRI 90+, 3000K 120V
<b>Size Options</b>	
<b>Certifications</b>	
<b>Available Finishes</b>	

\*Adjustable light direction

SA - Satin Aluminum, WT - White



- Machined Aluminum
- Title 24 listed
- ETL & cETL wet location listed, IP65 rated
- Available in 120V and 220V-277V
- Driver located within fixture
- Dimmable with Electronic Low Voltage dimmer
- 3000K Color Temperature
- 90+ CRI
- Fixture pivots 180° to direct light
- Coordinating pendants available (pg. 67)





SM451464SA

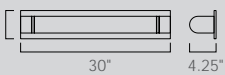
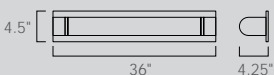

SM451465WT

\*220V & 277V available for special order

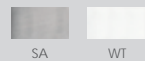
Model	SM451464	SM451465
Dimensions	30"W x 4.5"H x 4.25"E, 2.25"HCO	36"W x 4.5"H x 4.25"E, 2.25"HCO
Lamping	15W LED PCB (integrated) LED lm: 1050, Delivered lm: 580 CRI 90+, 3000K 120V	20W LED PCB (integrated) LED lm: 1400, Delivered lm: 750 CRI 90+, 3000K 120V
Size Options	4.5"  30" 4.25"	4.5"  36" 4.25"
Certifications		
Available Finishes	 SA WT	

SA - Satin Aluminum, WT - White



\*Light pivots 180°

\*220V & 277V available for special order

<b>Model</b>	SM451463
<b>Dimensions</b>	24"W x 4.5"H x 4.25"E, 2.25"HCO
<b>Lamping</b>	10W LED (integrated) LED lm: 700, Delivered lm: 420 CRI 90+, 3000K 120V
<b>Size Options</b>	4.5" 
<b>Certifications</b>	
<b>Available Finishes</b>	 SA WT

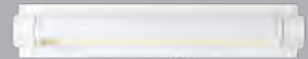

SM451463WT

SA - Satin Aluminum, WT - White



SM451348SA

\*220V & 277V available for special order

<b>Model</b>	SM451348
<b>Dimensions</b>	4.5"W x 96"H x 2.25"E, 48"HCO
<b>Lamping</b>	60W LED PCB (integrated) LED lm: 4200 CRI 90+, 3000K 120V
<b>Size Options</b>	
<b>Certifications</b>	
<b>Available Finishes</b>	

BZ - Bronze, SA- Satin Aluminum, WT - White



- Machined Aluminum
- ADA Compliant
- ETL & cETL wet location listed, IP65 rated
- Available in 120V and 220V-277V
- Driver located within fixture
- Dimmable with Electronic Low Voltage dimmer
- 3000K Color Temperature
- 90+ CRI
- Indirect backlight
- 8' version available



SM451346BZ



SM451344WT

\*220V & 277V available for special order

Model	SM451346	SM451344
Dimensions	4.5"W x 73"H x 2.25"E, 36.5"HCO	4.5"W x 51"H x 2.25"E, 25.5"HCO
Lamping	50W LED PCB (integrated) LED lm: 3500 CRI 90+, 3000K 120V	30W LED PCB (integrated) LED lm: 2100 CRI 90+, 3000K 120V
Size Options		
Certifications		
Available Finishes		

BZ - Bronze, SA- Satin Aluminum, WT - White



- Machined Aluminum
- ADA Compliant
- Title 24 listed
- ETL & cETL wet location listed, IP65 rated
- Available in 120V and 220V-277V
- Driver located within fixture
- Dimmable with Electronic Low Voltage dimmer
- 3000K Color Temperature
- 90+ CRI
- Directionally adjustable in field
- Coordinating pendants available (pg. 65)



SM451440WT



\*220V & 277V available for special order

Model	SM451440
Dimensions	4.75"W x 31"H x 4"E, 25"HCO
Lamping	7W LED PCB (integrated) LED lm: 490, Delivered lm: 420 CRI 90+, 3000K 120V
Size Options	
Certifications	
Available Finishes	

SA - Satin Aluminum, WT - White

# CEILING

Available in various shapes and colors, this collection of pendants and flush mounts provide a full range of streamlined, architectural design. Cast and extruded pieces of aluminum provide illumination that complement the sleek styling of commercial applications and minimalist modern design. Be it over a table or a work station, these versatile products direct lighting for both task and decorative uses.



- Machined Aluminum
- Available in 120V and 220V-277V
- Driver located within fixture
- Dimmable with Electronic Low Voltage dimmer
- 3000K Color Temperature
- 90+ CRI
- Air-tight cables are field adjustable
- Coordinating outdoor wall sconce (pg. 59)

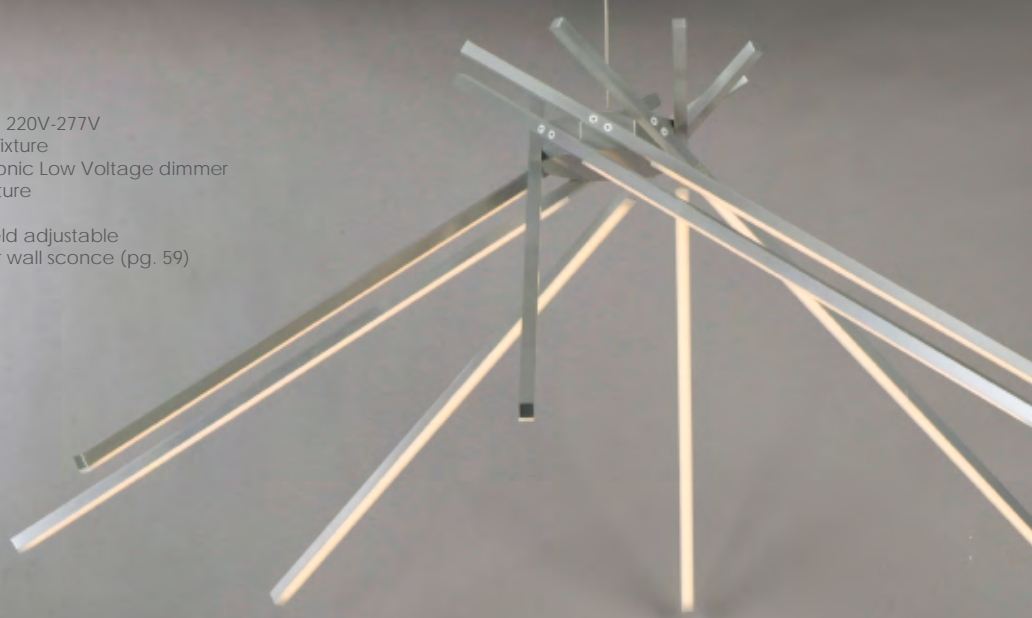

\*220V & 277V available for special order

<b>Model</b>	SM451445
<b>Dimensions</b>	44.75" D x 16.25" H, 138.5" Max OA
<b>Lamping</b>	27W LED PCB (integrated) LED lm: 1890, Delivered lm: 1769 CRI 90+, 3000K 120V
<b>Size Options</b>	
<b>Certifications</b>	
<b>Available Finishes</b>	

SA - Satin Aluminum, WT - White

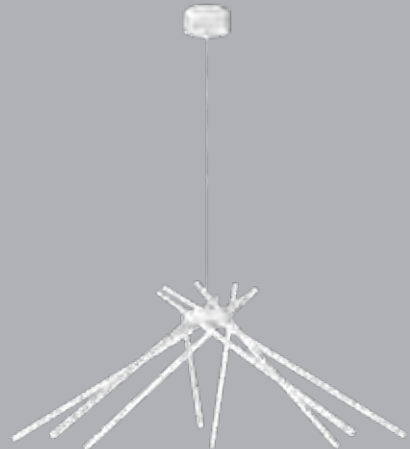

SM451445WT

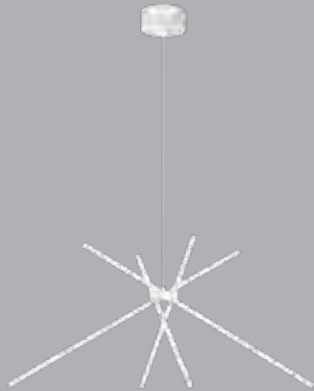

SM451443WT



SM451446SA

\*220V & 277V available for special order

Model	SM451443	SM451446
Dimensions	44.5" D x 20.25" H, 135.25" Max OA	44.5" D x 20.25" H, 135.5" Max OA
Lamping	23W LED PCB (integrated) LED lm: 1610, Delivered lm: 1495 CRI 90+, 3000K 120V	60W LED PCB (integrated) LED lm: 4200, Delivered lm: 3932 CRI 90+, 3000K 120V
Size Options		
Certifications		
Available Finishes		

SA - Satin Aluminum, WT - White





- Machined Aluminum
- ADA Compliant
- Title 24 listed
- Available in 120V and 220V-277V
- Driver located within fixture
- Dimmable with Electronic Low Voltage dimmer
- 3000K Color Temperature
- 90+ CRI
- 4' & 5' lengths available
- Air-tight cables are field adjustable
- Coordinating wall sconce & vanities available (pg. 55)

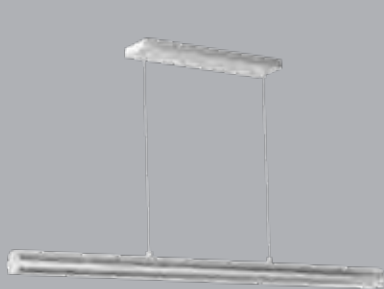

SM451467SA

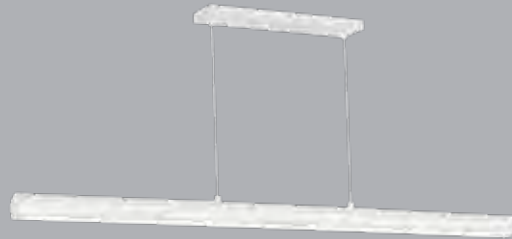

SM451468WT

\*220V & 277V available for special order

Model	SM451467	SM451468
Dimensions	4.5"W x 2.75"H x 46.75"L, 122.5" Max OA	4.5"W x 2.75"H x 58.25"L, 122.5" Max OA
Lamping	30W LED PCB (Integrated) Rated lm: 2100 CRI 90+, 3000K 120V	35W LED PCB (Integrated) Rated lm: 2450 CRI 90+, 3000K 120V
Size Options		
Certifications		
Available Finishes		

SA - Satin Aluminum, WT - White

- Machined Aluminum
- Title 24 listed
- ETL & cETL wet location listed, IP65 rated
- Available in 120V and 220V-277V
- Driver located within fixture
- Dimmable with Electronic Low Voltage dimmer
- 3000K Color Temperature
- 90+ CRI
- Twisted 120V wire
- Air-tight cables are field adjustable

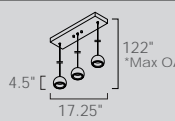

\*220V & 277V available for special order

Model	SM451484
Dimensions	4.5"W x 3"H x 17.25"L, 122" Max OA
Lamping	3 x 4W LED PCB (integrated) LED lm: 930, Delivered lm: 840 CRI 90+, 3000K 210V
Size Options	
Certifications	
Available Finishes	 WT

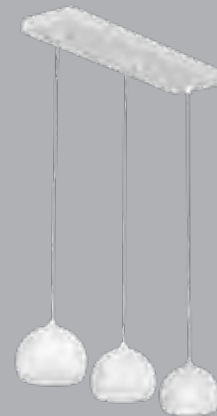

SM451484WT

WT - White



SM451481WT



SM451483WT

\*220V & 277V available for special order

Model	SM451481	SM451483
Dimensions	4.75" D x 3"H, 121.5" Max OA	10" D x 3.75"H, 122" Max OA
Lamping	4W LED PCB (integrated) LED lm: 360, Delivered lm: 310 CRI 90+, 3000K 120V	3 x 4W LED PCB (integrated) LED lm: 930, Delivered lm: 840 CRI 90+, 3000K 120V
Size Options	<p>121.5" *Max OA</p> <p>3" 4.75"</p>	<p>122" *Max OA</p> <p>3.75" 10"</p>
Certifications		
Available Finishes	 WT	

WT - White

# PATHWAYS

Provide safe and functional lighting along your paths by adding spot lighting and bollards. These machined aluminum products enhance the architectural elements of your home by using techniques like grazing and uplighting. Whether you choose to accentuate an object of interest or extend your living space, this collection has the sleek and slim profile to blend seamlessly into your pathways.





- Machined Aluminum
- Title 24 listed
- ETL & cETL wet location listed, IP65 rated
- Available in 120V and 220V-277V
- 12V LED, compatible with landscape lighting
- Driver located within fixture
- 35,000 hours rated life
- 3000K Color Temperature
- 80+ CRI
- Includes spike and concrete bolts



SM451364SA

\*220V & 277V available for special order

Model	SM451364
Dimensions	3"W x 34"H
Lamping	3W LED PCB (included) Delivered lm: 210 CRI 80+, 3000K 12V
Size Options	23.75" 34" 
Certifications	
Available Finishes	 BZ SA

BZ - Bronze, SA - Satin Aluminum



- Machined Aluminum
- Title 24 listed
- ETL & cETL wet location listed, IP65 rated
- Available in 120V and 220V-277V
- 12V LED, compatible with landscape lighting
- Driver located within fixture
- 35,000 hours rated life
- 3000K Color Temperature
- 80+ CRI
- Adjustable spot lighting
- Includes spike and concrete bolts



SM451350SA



Model	SM451350
Dimensions	3.5"W x 13.75"H
Lamping	3W LED MR16 (included) Delivered lm: 230 CRI 80+, 3000K 12V
Size Options	
Certifications	
Available Finishes	 BZ SA

BZ - Bronze, SA - Satin Aluminum





- Machined Aluminum
- Title 24 listed
- ETL & cETL wet location listed, IP65 rated
- Available in 120V and 220V-277V
- 12V LED, compatible with landscape lighting
- Driver located within fixture
- 3000K Color Temperature
- 90+ CRI
- Includes spike and concrete bolts



SM451357BK



SM451358BK

Model	SM451357	SM451358
Dimensions	5.75"W x 3.75"H	5.75"W x 4"H
Lamping	12W LED PCB (integrated) LED Im: 840, Delivered Im: 220 CRI 90+, 3000K 12V	9W LED PCB (integrated) LED Im: 630, Delivered Im: 250 CRI 90+, 3000K 12V
Size Options		
Certifications		
Available Finishes	 BK	

BK - Black

- Machined Aluminum
- Title 24 listed
- ETL & cETL wet location listed, IP65 rated
- Available in 120V and 220V-277V
- 12V LED, compatible with landscape lighting
- Driver located within fixture
- 3000K Color Temperature
- 90+ CRI
- Includes spike and concrete bolts



SM451370GY

\*220V & 277V available for special order

Model	SM451370
Dimensions	5"W x 23.5"H x 5"L
Lamping	12W LED PCB (integrated) LED lm: 840, Delivered lm: 450 CRI 90+, 3000K 12V
Size Options	
Certifications	
Available Finishes	 BZ      GY

BZ - Bronze, SA - Satin Aluminum



- Machined Aluminum
- Title 24 listed
- ETL & cETL wet location listed, IP65 rated
- Available in 120V and 220V-277V
- 12V LED, compatible with landscape lighting
- Driver located within fixture
- 35,000 hours rated life
- 3000K Color Temperature
- 80+ CRI
- Includes spike and concrete bolts



SM451365SA

\*220V & 277V available for special order

Model	SM451365
Dimensions	6"W x 34"H
Lamping	6W LED PCB (integrated) LED lm: 420, Delivered lm: 216 CRI 80+, 3000K 12V
Size Options	
Certifications	
Available Finishes	

BZ - Bronze, SA - Satin Aluminum



- Machined Aluminum
- Title 24 listed
- ETL & cETL wet location listed, IP65 rated
- Available in 120V and 220V-277V
- 12V LED, compatible with landscape lighting
- Driver located within fixture
- 35,000 hours rated life
- 3000K Color Temperature
- 80+ CRI
- Includes spike and concrete bolts
- Coordinating wall sconce available (pg. 51)



SM451369BZ



\*220V & 277V available for special order

Model	SM451369
Dimensions	5.25"W x 30"H x 7.25"L
Lamping	9.8W LED PCB (integrated) LED Im: 690, Delivered Im: 480 CRI 80+, 3000K 12V
Size Options	
Certifications	
Available Finishes	

BZ - Bronze, SA - Satin Aluminum

- Machined Aluminum
- Title 24 listed
- ETL & cETL wet location listed, IP65 rated
- Available in 120V and 220V-277V
- 12V LED, compatible with landscape lighting
- Driver located within fixture
- 35,000 hours rated life
- 3000K Color Temperature
- 80+ CRI
- Includes spike and concrete bolts
- Coordinating wall sconce available (pg. 51)



SM451366BZ



\*220V & 277V available for special order

Model	SM451366
Dimensions	4"W x 34"H
Lamping	5.4W LED PCB (integrated) LED lm: 420, Delivered lm: 298 CRI 80+, 3000K 12V
Size Options	23.75" 34" 4"
Certifications	LED ETL CA 2
Available Finishes	BZ SA

BZ - Bronze, SA - Satin Aluminum

- Machined Aluminum
- Title 24 listed
- ETL & cETL wet location listed, IP65 rated
- Available in 120V and 220V-277V
- 12V LED, compatible with landscape lighting
- Driver located within fixture
- 35,000 hours rated life
- 3000K Color Temperature
- 80+ CRI
- Includes spike and concrete bolts



SM451371BZ



\*220V & 277V available for special order

Model	SM451371
Dimensions	3.25"W x 24"H x 7"L
Lamping	3W LED PCB (Integrated) LED lm: 210, Delivered lm: 176 CRI 80+, 3000K 12V
Size Options	
Certifications	
Available Finishes	

BZ - Bronze, SA - Satin Aluminum

- Machined Aluminum
- Title 24 listed
- ETL & cETL wet location listed, IP65 rated
- Available in 120V and 220V-277V
- 12V LED, compatible with landscape lighting
- Driver located within fixture
- 35,000 hours rated life
- 3000K Color Temperature
- 80+ CRI
- Includes spike and concrete bolts



SM451383BZ

\*220V & 277V available for special order

Model	SM451383
Dimensions	2"W x 23.75"H x 6"L
Lamping	8.4W LED (integrated) LED lm: 588, Delivered lm: 400 CRI 90+, 3000K 12V
Size Options	
Certifications	
Available Finishes	

BZ - Bronze, WT - White



- Machined Aluminum
- ETL & cETL wet location listed, IP65 rated
- Available in 120V and 220V-277V
- 12V LED, compatible with landscape lighting
- Driver located within fixture
- 3000K Color Temperature
- 90+ CRI
- Includes spike and concrete bolts
- Coordinating wall sconces available (pg. 48)







\*220V & 277V available for special order

Model	SM451049
Dimensions	4"W x 13.5"H x 13.75"L
Lamping	4W LED PCB (integrated) Rated lm: 840, Delivered lm: 610 CRI 90+, 3000K 12V
Size Options	
Certifications	
Available Finishes	



SM451049WT

BZ - Bronze, WT - White

- Machined Aluminum
- ADA Compliant
- ETL & cETL wet location listed, IP65 rated
- 12V & 120V versions available
- Driver located within fixture
- 3000K Color Temperature

\* Required for installation  
\* Sold separately





SM452400



SM451403BZ

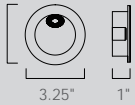

SM451404SA

<b>Model</b>	SM451403 / SM452403	SM451404 / SM452404
<b>Dimensions</b>	3.25"W x 3.25"H x 1.5"E, 3"HCO	3.25"W x 3.25"H x 1.5"E, 3"HCO
<b>Lamping</b>	2W LED PCB (integrated) LED lm: 180, Delivered lm: 70 CRI 90+ / CRI 80+, 3000K 12V / 120V	2W LED PCB (integrated) LED lm: 180, Delivered lm: 70 CRI 90+ / CRI 80+, 3000K 12V / 120V
<b>Size Options</b>	3.25"  3.25" 1"	3.25"  3.25" 1"
<b>Certifications</b>		
<b>Available Finishes</b>	 BZ SA WT	

BZ - Bronze, SA - Satin Aluminum, WT - White



