

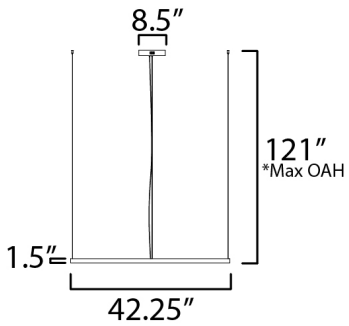

PRODUCT DESCRIPTION



MEASUREMENTS

DIMENSION : 42.25" L x 31.25" W x 1.5" H
 MAX OAH : 121" OAH
 CANOPY : 8.5" W x 1.75" H x 8.5" L
 HANGING WEIGHT : 9.9 lb

LAMPING

INPUT VOLTAGE : 120-277V
 LUMENS : 4,160 Rated (2,080 Del.)
 BULB : 52W LED DC Integrated , 52W Total
 BULB INCLUDED : (Integrated)
 DIMMABLE : Triac, ELV, 0-10V
 CRI : 90 CRI
 COLOR_TEMP : 3000K

FINISHES OPTION

 Brushed Champagne (BCN)

MATERIAL

Stainless Steel,PC

RATINGS

cETLus
 Dry Location



ADDITIONAL

SLOPE:
 RATED LIFE 20000 Hours
 OPERATING TEMPERATURE:
 -20°C (-4°F), 40°C (104°F)

Always consult a qualified electrician before installing any lighting product.



Modifications or Customizations: Please email contract@studiomlighting.com
Sample Request: Please email order@studiomlighting.com with subject line
 "Sample Order_ [Project Name] / [Specifier/Designer]"
 All samples are subject to Studio M approval and must show proof of project and/or explanation.

Job Name:	Job Type:
Quantity:	Comments: